

Agenda Item	6.6
Report No	PLS-060-21

HIGHLAND COUNCIL

Committee: South Planning Applications Committee

Date: 17 August 2021

Report Title: 20/01442/PIP: Mr Garry Macdonald
Land Between the Heights and El Palamino, Ladystone
Bunchrew, Inverness

Report By: Area Planning Manager – South

Purpose/Executive Summary

Description: Formation of house plot (in lieu of Plot 2 (17/05112/PIP))

Ward: 12 – Aird and Loch Ness

Development category: Local

Reason referred to Committee: Objection from Community Council

All relevant matters have been taken into account when appraising this application. It is considered that the proposal does not accord with the Development Plan however it is acceptable in terms of applicable material considerations.

Recommendation

Members are asked to agree the recommendation to **GRANT** the application as set out in section 11 of the report.

1. PROPOSED DEVELOPMENT

- 1.1 The application is in principle for the development of a 1½ storey house and garage in an elevated location at Ladystone, to the west Inverness and to the south of Bunchrew. The proposal seeks to effectively 'swap' with a housing site to the south which has an extant planning permission (17/05112/PIP).
- 1.2 The application site boundary extends from the access track on the north east boundary in a south west direction to incorporate the two sites which were originally granted planning permission in 1996 (IN/1994/745). Plot 1 has been developed (Wolves' Den) and Plot 2 remains undeveloped. It is Plot 2 that the applicant wishes to 'swap' for the current planning application site.
- 1.3 The site is located approximately midway between 2 houses, The Heights (to the west), and El Palamino (to the east), with a frontage onto the access track to the north east. Between the site and The Heights there is an access track, which leads south west to the Wolves' Den and another house plot, which has an extant planning permission and is within the ownership of the applicant.
- 1.4 The distance from El Palamino to the closest point of the indicative house position is approximately 102m. The site is set within an existing cleared area following the previous removal of several smaller trees and within this, the indicative house orientation is similar to that of the two adjacent properties.
- 1.5 Vehicular access to the site will be taken initially from an access track on the north boundary of the site which serves 3 existing houses: The Heights, Wolves' Den and El Palamino. The applicant owns some of this access track. This access track connects to the Ladystone Farm Road to the west and also to the access track to the east, which leads north to connect with the public road at Leachkin Brae. The latter track is the intended access for the house site to avoid use of the Ladystone Road and this was a legal requirement of permission IN/1994/745. The applicant has access rights over the access track leading north to Leackhin Brae.
- 1.6 The application is supported by indicative plans showing how a house could be set out on the site, and the type of building design envisaged, including external material finishes with a mixture of grey timber cladding, natural stone and a slate roof. The proposed house is indicatively shown set centrally within the site on a north west – south east axis with an integral garage on the south east elevation.
- 1.7 Pre-Application Consultation: None
- 1.8 Supporting Information: Design Statement and Addendum, Arboricultural Impact Assessment / Method Statement, Protected Species Survey Report
- 1.9 Variations: (19.08.2020) - Tree Constraints Plan, Tree Planting Plan, Tree Protection Plan, Arboricultural Impact Assessment / Method Statement, Protected Species Survey Report (03.09.2020).

2. SITE DESCRIPTION

- 2.1 The site is located in an elevated location to the west side of Inverness at Ladystone. It is situated within a woodland consisting of deciduous and coniferous trees, which in turn forms part of a linear woodland which extends from The Heights to the southwest to El Palamino in the northeast. On the northeast boundary the site is bounded by an access track which connects to the Ladystone Farm Road to the northwest, and an access track to the southeast, which in turn leads north to connect into the public road at Leachkin Brae. To the northeast there are open fields and on the southwest boundary there is a gap as result of the 132kv overhead electricity line.

3. PLANNING HISTORY

- | | | | |
|-----|------------|---|--|
| 3.1 | | IN/1994/745, IN/1995/417, IN/1996/548, IN/1996/742 – Various applications for 2 houses within the wider site. | Planning Permission Granted |
| 3.2 | 21.01.2010 | 09/00762/PIPIN - Erection of two houses. This is on the original larger site. | Planning Permission in Principle Granted |
| 3.3 | 17.03.2013 | 13/00071/S42 - Renewal of Planning Permission (09/00762/PIPIN). This is on the original larger site. | Planning Permission Granted |
| 3.4 | 15.08.2014 | 14/02704/FUL - Erection of house and garage (Wolves Den) and 1 of the 2 house plots granted with 09/00762/PIPIN. This is on the southern part of the original larger site | Planning Permission Granted |
| 3.5 | 22.12.2017 | 17/05112/PIP - Erection of house (renewal of permission 13/00071/S42). This is on the original larger site to the north of the Wolves Den (14/02704/FUL) | Permission in Principle Granted |
| 3.6 | 03.12.2019 | 19/04489/FUL - Erection of house and garage (amended design 14/02704/FUL). Site at the Wolves Den to the south of current application site (20/01442/PIP) | Permission Granted |

Material to the consideration of the application is the recent Planning history of Ladystone Farm Steading around 450m to the west, which was considered by Committee on 09.03.202, was Refused, and is subject of Appeal:

20/02342/PIP Conversion of steading to form short term let holiday accommodation (10 units) and associated facilities at Ladystone Farm Steading was refused on the following grounds:

1. The proposal is contrary to Policy 28 of the Highland wide Local Development Plan and Policy 3 of the Inner Moray Firth Local Development Plan as the

proposal will result in a significant increase in activity that would have a detrimental impact on the amenity of neighbouring occupiers and recreational users and is not compatible with the scattered residential character of this part of the settlement of Ladystone.

2. The proposal is contrary to Policy 28 of the Highland wide Local Development Plan as the development will have a significant adverse impact on the existing road network as well as impacting on the recreational use of the area.

4. **PUBLIC PARTICIPATION**

4.1 Advertised: Unknown Neighbour

Date Advertised: 01.05.2020

Representation deadline: 15.05.2020

Timeous representations: 3

Late representations: 3

4.2 There are 4 letters of objection, 1 letter of support and 1 neutral comment

Material considerations raised are summarised as follows:

- a) Application is business venture. Precedent for further applications
- b) No justification for new house. Permission 17/05112/PIP has lapsed.
- c) Contrary to Policy 35 of HwLDP as site within the Hinterland and presumption against housing in the open countryside
- d) Amenity – removal of woodland setting and reduce degree of separation between The Heights and El Palamino and impinge on their amenity and privacy. Does not follow existing pattern of development as orientation of new house north/south while 2 houses are east-west.
- e) Design – traditional design does not reflect design of nearest houses (The Heights and El Palamino)
- f) Trees - will require a lot of mature pine trees to be felled and contrary to Scottish Government's Control of Woodland Removal
- g) Protected species and wildlife – site more sensitive than Plot 2 (17/05112/PIP). Evidence of badgers and red squirrels in immediate vicinity. Pine marten and bats active in the area around the junction of the access track leading to the site with the track leading down to Plot 2 (17/05112/PIP). Needs appropriate surveys. Moths and snipes use the site
- h) Roads – Leachkin Brae is single track road in need of repair and suitable for current level of residential traffic. Use of track via Leachkin Brae to serve house site may increase traffic along that track and past house at The Heights. Track leading to Leachkin Brae upgraded by SSE in 2018 but already deteriorated and shows problem of road maintenance. Network Rail requested erection of a barrier to prevent use of Ladystone Farm Road. Difficult enforcing that Ladystone Farm Road across railway bridge will never be used.

4.3 All letters of representation are available for inspection via the Council's eplanning portal which can be accessed through the internet www.wam.highland.gov.uk/wam.

5. CONSULTATIONS

5.1 **Kirkhill & Bunchrew Community Council:** Object on the basis that traffic from the development will use the Ladystone road to access the A862. This road is in a poor and deteriorating condition, narrow without passing places and crosses a substandard railway bridge. The alternative access proposed to Leachkin Brae is a substandard deteriorating temporary surface which is unlikely to be used. Understand that a significant number of mature trees have been cleared from the site in advance of the application without permission. If there are pressured areas in the hinterland, then perhaps these should be pulled out in the next review of the Inner Moray Firth Local Development Plan.

5.2 **Transport Planning Team** considers this a renewal of permission 17/05112/PIP albeit the house position is different. The vehicular access over the railway bridge is a matter for Network Rail. Ladystone Farm Road is privately owned and maintained. The Council does not have the power to insist on which route a driver takes to join the public road. If there is the slightest possibility that vehicular access can be taken from Leachkin Brae, the Council should seek a developer contribution from every future development that comes forward.

5.3 **Forestry Officer:** Objects to the proposal. The site is within semi-mature Scots Pine woodland with occasional Rowan and Juniper. The pine trees are quite tightly spaced and there were no significant clearings within the woodland. The Arboricultural Impact Assessment (AIA) identifies 84 trees of which 33 trees would be removed. The proposed Tree Protection Plan shows the clearance of a significant area of woodland and would create a lengthy non-windfirm edge which would be vulnerable to wind blow. Concerned that this would result in further tree felling should permission be granted.

Proposed tree planting within the site is in open ground and would be acceptable. Tree felling outwith the site is within existing woodland and would not represent creation of new woodland to replace what would be lost to development.

Do not consider proposal accords with policy 51, 52, 57, and Scottish Government's Control of Woodland Removal Policy.

5.4 **Access Officer:** Access for this proposed development coincides with a path and Core Path (L019.50). Recommend conditions in relation to the paths during any development.

5.5 **Network Rail** has concerns regarding the possible intensification of use of Overbridge 302/017 and are unconvinced that the access solution proposed by the developer to prevent the use of the bridge can be implemented without additional mitigation measures in place.

Network Rail therefore object to this application unless conditions are attached to the planning permission relating to the provision of a safe and suitable access route from Leachkin Brae to the development, with no development taking place on site until the access road from Leachkin Brae to the development site is upgraded to a suitable standard. It also advises that construction traffic and emergency vehicles must not use Overbridge 302/017 due to the weight restrictions and the potential impact on the safety of the railway.

6. DEVELOPMENT PLAN POLICY

The following policies are relevant to the assessment of the application

6.1 Highland Wide Local Development Plan 2012

- 28 - Sustainable Design
- 29 - Design Quality & Place-making
- 30 - Physical Constraints
- 31 - Developer Contributions
- 35 - Housing in the Countryside (Hinterland Areas)
- 51 - Trees and Development
- 52 - Principle of Development in Woodland
- 56 - Travel
- 57 - Natural, Built & Cultural Heritage
- 58 - Protected Species
- 65 - Waste Water Treatment
- 66 - Surface Water Drainage
- 77 - Public Access
- 78 - Long Distance Routes

6.2 Inner Moray Firth Local Development Plan 2015

Policy 3: Other Settlements - Bunchrew

6.3 Highland Council Supplementary Planning Policy Guidance

- Access to Single Houses and Small Housing Developments (May 2011)
- Developer Contributions (March 2013)
- Highland's Statutorily Protected Species (March 2013)
- Sustainable Design Guide (Jan 2013)
- Physical Constraints (March 2013)
- Housing in the Countryside and Siting and Design (March 2013)
- Trees, Woodlands and Development (Jan 2013)

7. OTHER MATERIAL POLICY CONSIDERATIONS

7.1 Scottish Government Planning Policy and Guidance

Scottish Planning Policy (The Scottish Government, June 2014)

Section 218 - Control of Woodland Removal. The Scottish Government's Control of Woodland Removal Policy [92] includes a presumption in favour of protecting woodland. Removal should only be permitted where it would achieve significant and clearly defined additional public benefits. Where woodland is removed in association with development, developers will generally be expected to provide compensatory planting. The criteria for determining the acceptability of woodland removal and further information on the implementation of the policy is explained in the Control of Woodland Removal Policy, and this should be taken into account when preparing development plans and determining planning applications.

7.2 **The Highland Council - Core Paths Plan**

Core Paths in Inverness and Nairn

8. **PLANNING APPRAISAL**

8.1 Section 25 of the Town and Country Planning (Scotland) Act 1997 requires planning applications to be determined in accordance with the development plan unless material considerations indicate otherwise.

Determining Issues

8.2 This means that the application requires to be assessed against all policies of the Development Plan relevant to the application, all national and local policy guidance and all other material considerations relevant to the application.

Planning Considerations

8.3 The key considerations in this case are:

- a) the justification for this application
 - b) compliance with the development plan and other planning policy
 - c) layout and design
 - d) existing infrastructure constraints
 - e) access arrangements, traffic and road safety
- a) impact on woodland resource
 - b) habitats and protected species
 - c) any other material considerations.

Development plan/other planning policy

8.4 The site adjoins the settlement of Bunchrew and therefore Policy 3 of the Inner Moray Firth Local Development Plan is relevant. Given that it lies within the Hinterland of Inverness, Policy 35 of HwLDP applies along with the Supplementary Guidance on Housing in the Countryside: Siting and Design. As with all development proposals, consideration must be given to how the proposal addresses the criteria listed within Policy 28.

8.5 Policy 35 of Highland-wide Local Development Plan (HwLDP) is relevant and presumes against housing in the Hinterland unless it meets one or more of the relevant criteria including:

- Land management
- Agricultural retirement
- Affordable housing
- Existing or new rural business
- Replacement of an existing house which does not meet the requirements for modern living and where the costs of upgrading are not justified on economic or environmental grounds

- Conversion or reuse of traditional buildings or redevelopment of derelict land; development of brownfield sites
- Expansion of a housing group (3 or more houses), or development within garden ground

In this instance none of the criteria apply.

- 8.6 Policy 28 of Highland-wide Local Development Plan (HwLDP) supports development subject to a number of criteria and the most relevant in this case are: the impact on individual and community residential amenity; and sensitive siting and high-quality design in keeping with the local character with the use of appropriate materials.
- 8.7 Given the presumption against housing in the Hinterland and that the application does not advance a justification for an exception, the proposal is contrary to the Development Plan. Having said that, planning history is relevant to the determination of this proposal. This must rightly be taken into consideration along with the other policies contained within the Development Plan and other material considerations.

Layout and design

- 8.8 The indicative plans show that a house could be set centrally within the application site, orientated at a right angle to the track to the north with the gables on a northwest-southeast axis with an integral garage on the southeast elevation. The two neighbouring houses, The Heights (70m to the west) and El Palamino (40m to the east) are orientated with their frontages onto the track to the north. The indicative design is 1½ storeys which results in a reduced footprint compared to the single storey houses at The Heights and El Palamino.
- 8.9 There is woodland between the plot and both of the existing neighbouring houses. This provides screening, physical separation, and reinforcement of the established building pattern. The proposal includes additional boundary woodland cover with the applicant having control and ownership of the adjoining land so that any additional restocking and tree planting can be undertaken within the area.
- 8.10 As the application is in principle, and the submitted plans show an indicative design of house and placement and orientation on the site, a further application would be required in order to confirm the details of the building. Notwithstanding this, the representative indicative plans provide a degree of comfort to show how the site could be developed for a single house without detriment to the established amenity of the neighbouring houses, The Heights, and El Palamino.

Existing infrastructure constraints

- 8.11 A number of planning applications for residential and holiday enterprises within the Ladystone area have been refused in recent years. One of the key reasons for this relates to the access arrangements; the reliance on the use of the substandard Ladystone Road, the need to cross the weight restricted railway bridge at Bunchrew, and the safety aspects associated with the inadequate junction arrangement on the A832, particularly with regard to visibility. The ongoing use of the railway bridge and substandard Ladystone Road has been a cause for some concern for local residents and the Community Council, which has consistently raised objections to these

applications with a call for the road to be adopted. Representations received for this proposal reference these concerns again.

- 8.12 The Council has no plans to adopt this road. It is not of sufficient standard to do so. Network Rail has regularly objected to any new development on Ladystone Road on the basis that the intensification of traffic flow over the private, weight restricted bridge will increase the safety risk to both rail passengers and road users. While the bridge is entirely safe and meets the standards for the purpose it was built, to provide vehicular access for the landowner, any increase in traffic flows could increase the risk of an accident and vehicle incursion.
- 8.13 Policy 30 - Physical Constraints of the Highland-wide Local Development Plan requires developers to consider whether their proposals would be located within areas of constraints as set out in the Physical Constraints Supplementary Guidance. Where a proposed development is affected by any of the constraints detailed within the guidance, developers must demonstrate compatibility with the constraint or outline appropriate mitigation measures. In relation to railway infrastructure, the guidance states that “any new development can potentially pose a risk to the running of the operational railway or impact on existing railway infrastructure such as: bridges; tunnels; embankments; railway access; and level crossings. There are a significant number of level crossings in the Highland Local Authority Area. Development proposals that are likely to result in a significant percentage increase in level crossing use must assess level crossing capacity and potential safety impacts borne from proposals including appropriate mitigation where necessary”. As such, development is only permitted if sufficient mitigation measures are in place.

Access arrangements, traffic and road safety

- 8.14 The ongoing use of Leachkin Brae and the proposed use of the drove road has also caused considerable concern for local residents and the Community Council, which has also consistently raised objections to applications for further development in this area on that basis. This single-track road serves approximately 48 dwellings, a number of businesses including Wester Blackpark Farm, and the Forestry and Land Scotland car park used for the purpose of accessing trails around Craig Phadraig hill and old fort. Only a portion of the single track Leachkin Brae is adopted with limited passing opportunities and no pedestrian footway provision.
- 8.15 There are a number of passing places along the adopted section of Leachkin Brae that require upgrading. Only a short section of the old drove road forms part of the adopted road, with the majority of the proposed access unadopted, substandard and in a poor state of repair; essentially a rough track that joins the Great Glen Way beyond the boundary of the former Craig Dunain hospital estate boundary. This track is well used locally for a mixture of recreational uses including hill walkers, recreational walkers, dog walkers, joggers and horse riders all making use of the Core Path.
- 8.16 The use of the Leachkin Brae route presents a number of challenges. Representations question the principle of the use of the drove road access, the capacity of the road to accept additional traffic and road safety particularly where the drove road meets the Great Glen Way.

- 8.17 Furthermore, representations refer to the potential for use of the Ladystone Farm Road, which leads to the substandard railway bridge. Network Rail has not objected provided a condition can be imposed relating to the upgrading of the Leachkin Brae access before the commencement of development on the site; and that construction traffic use this route only.
- 8.18 In this instance, the extant planning permission is a material consideration and the applicant is entitled to apply for an application for Matters Specified in Conditions (for 17/05112/PIP) without consideration of the vehicular access. Capacity would not be an issue for this application. There would be no overall increase in vehicle traffic with a new house (20/01442/PIP) from that already agreed under the extant permission (17/05112/PIP) subject to the latter permission being revoked.
- 8.19 Notwithstanding this, access has to be considered specifically for the current proposal.
- 8.20 In order to avoid the use of Ladystone Farm road (and therefore the overbridge (302/017) at Bunchrew) the applicant has suggested that a lockable gate could be provided on the access track, therefore preventing traffic going towards the bridge. This would require agreement of those parties with an interest in the track, and it has not been clarified by the applicant whether such an agreement is in place. In addition to this, surfacing of the road to adoptable standard, from El Palamino to Leachkin Brae would encourage the use of this access to the east to Leachkin Brae, rather than to the west / north to the Ladystone Farm road / railway overbridge.
- 8.21 It should be noted that if a condition is not attached, then Network Rail would object as a Statutory Consultee and the application would have to be referred to the Scottish Ministers for determination.
- 8.22 Accordingly, a condition is recommended for an upgrade of the Leachkin Brae/drove road access.

Impact on woodland resource

- 8.23 Trees within the boundary of the site will need to be felled to form the curtilage of the house site. Otherwise the tree belt outwith the red line boundary will be retained so maintaining the screening in landscaping terms.
- 8.24 Policy 51 (Trees and Development) of the HwLDP states that 'the Council will support development which promotes significant protection to existing hedges, trees and woodlands on and around development sites. The acceptable developable area of a site is influenced by tree impact, and adequate separation distances will be required between established trees and any new development. Where appropriate a woodland management plan will be required to secure management of an existing resource'. The purpose of Policy 51 is to protect existing trees and hedges, supplement existing planting and, if required, compensate for any loss.
- 8.25 The woodland around the site will not be impacted by development so there is sufficient protection.

- 8.26 Policy 52 (Principle of Development in Woodland) of the HwLDP states that 'the applicant is expected to demonstrate the need to develop a wooded site and to show that the site has capacity to accommodate the development. The Council will maintain a strong presumption in favour of protecting woodland resources. Development proposals will only be supported where they offer clear and significant public benefit. Where this involves woodland removal, compensatory planting will usually be required.' The purpose of Policy 52 is to protect woodland resource.
- 8.27 This aspect of policy, which is set out in more detail within the Council's Trees, Woodlands and Development Supplementary Guidance stems from Section 218 of Scottish Planning Policy that states 'the Scottish Government's Control of Woodland Removal Policy includes a presumption in favour of protecting woodland. Removal should only be permitted where it would achieve significant and clearly defined additional public benefits. Where woodland is removed in association with development, developers will generally be expected to provide compensatory planting.'
- 8.28 The Control of Woodland Removal policy indicates that "public benefits include social, economic and environmental benefits, the latter including carbon considerations." It recognises that woodland removal, with compensatory planting, is most likely to be appropriate where it would contribute significantly to, amongst other things, enhancing sustainable economic growth or rural/community development, supporting Scotland as a tourist destination, encouraging recreational activities and public enjoyment of the outdoor environment and increasing the social, economic or environmental quality of Scotland's woodland cover.
- 8.29 The Forestry Officer considers that there is no public benefit arising from the proposal. While this would ordinarily be the position where considering a single house, unless where it would directly supporting a fragile community, this particular proposal may assist in betterment to the existing community through provision of an alternative access to Ladystone Road something that would not have been possible from developing the extant site beside The Wolves Den.
- 8.30 The applicant has provided information on where tree planting can take place elsewhere on land within their ownership. This planting would be equivalent to the area lost through development of the house site to meet the Scottish Government's Control of Woodland Removal Policy. It is considered that as an area of tree planting equivalent to that lost as part of the development of the site would be re-planted, the proposal could comply with Policy 52 (Principle of Development in Woodland).
- 8.31 The tree loss is considered to have an acceptable impact on the natural environment, amenity and heritage resource so meeting HwLDP Policy 57. The trees lost will not have a detrimental impact on the remaining woodland and the character, setting, amenity and/or containment of the housing or surrounding landscape.

Habitats and Protected Species

- 8.32 Protected species surveys and assessments were carried out in August 2020 and it was established that there are no signs of badgers, bats, otters, pine marten or wildcat on or around the site.

- 8.33 Two red squirrel dreys were located during the survey, including one within the site boundary and one within 30m to the west of the site boundary. The felling of trees containing dreys or works within 50m of breeding dreys requires a licence from NatureScot under the Wildlife and Countryside Act 1981, and therefore further surveys of the dreys are proposed. The preparation of a Species Protection Plan is considered an appropriate response to this.

Other material considerations

- 8.34 While the proposal is contrary to the Development Plan consideration must be given to other material considerations relevant to the application which might justify the grant of planning permission. In this instance, the applicant is seeking to revoke an existing permission (17/05112/PIP) in favour of a house on this site. That permission would have expired on 22.12.2020; however, the Town and Country Planning (Emergency Period and Extended Period) (Coronavirus) (Scotland) Regulations 2020 has extended its duration until 31 March 2022. It has therefore not lapsed and could yet be lawfully implemented.
- 8.35 It is considered that there is a reasonable case to revoke the extant permission (17/05112/PIP) which is close to the Wolves' Den to the southwest. This site is in closer proximity (around 30m) to an existing house, the Wolves' Den. The proposed house site sits within a larger plot with a greater degree separation from neighbouring properties. It would better reflect the established character of the existing houses in the area with an appropriate level of separation between existing houses. This proposal would maintain the established settlement pattern and will have no impact on the landscape character of the area. Accordingly, it is considered that this is a strong material reason to accept this proposal, subject to the revocation of the extant permission (17/05112/PIP).

Non-material considerations

- 8.36 A representation has suggested that the justification for the house site is based on a business venture.

Revocation of previous permission

- 8.37 If planning permission is granted then before the Decision Notice can be issued, the applicant would have to seek the revocation of Planning Permission (17/05112/PIP). This involves an Order which has to be confirmed by the Scottish Ministers. After that process is concluded this permission can be issued. The revocation process will thereby ensure that only one house is built.

Matters to be secured by Section 75 Agreement/upfront payment

- 8.38 Policy 31 requires that, where developments create a need for new or improved public services, facilities or infrastructure, the developer makes a fair and reasonable contribution in cash or kind towards these additional costs or requirements. The following is what would be required in the event that planning permission were to be granted.

Summary of Developer Contributions		
Infrastructure / Service Type	Select Answer	Contribution Rate Per Home (a small scale housing discount has already been applied)
Number of Homes Proposed	1	
Dochgarroch Primary School		
Build Costs	None - No capacity constraints	£0
Major Extension / New School - Land Costs	None - No land costs required	£0
Primary Total		£0
Charleston Academy		
Build Costs	Major extension / new school	£741
Major Extension / New School - Land Costs	None - No land costs required	£0
Secondary Total		£741
Affordable Housing		
CNPA	No	£0
Cumulative Transport		
Development Brief / Agreement Area	None - No cumulative transport costs required	£0
Breakdown	N/A	N/A
	N/A	N/A
	N/A	N/A
Total Per Home		£741
Total for Development		£741

All costs are subject to indexation (BCIS All-In TPI) and have been indexed to the appropriate quarter.

9. CONCLUSION

- 9.1 The proposal is for a single house placed between two existing houses – The Heights (70m to the west) and El Palamino (40m to the east).
- 9.2 Network Rail has objected to the development unless a condition in relation to the provision of a safe access from Leachkin Brae is provided. This could be achieved by the surfacing of the road to adoptable standard, from El Palamino to Leachkin Brae. This would encourage the use of the access to the east for Leachkin Brae, rather than to the west/north to the Ladystone Farm road / railway overbridge.
- 9.3 The development of a single house at this location within the hinterland area around Inverness is considered to be contrary to the development plan policy 35 Housing in the Countryside (Hinterland areas). The policy does set out exceptions which allow for a house; however, none of these exceptions apply in this instance.

- 9.4 Material to the consideration of the application is the Planning history of the area. There is an extant planning permission (17/05112/PIP) for a house to the southwest. The applicants seek to have this permission revoked, in favour of the current proposal. Effectively, the current proposal (20/01442/PIP), if approved, would swap with this extant planning permission (17/05112/PIP).
- 9.5 The positioning of the current proposal is framed by established tree cover; this provides an appropriate degree of screening and separation, so as to ensure individual and community residential amenity and privacy for both the existing and proposed house as required by Development Plan Policy 28.
- 9.6 It is not considered that the proposal will be visually intrusive in the landscape and despite the removal of trees to form the house site, the woodland surrounding the site can be retained without detriment to the area as a whole. The applicant has sufficient land to plant trees to compensate for those lost from the site.
- 9.7 The development of a house on the site would result, when combined with the revocation of planning permission (17/05112/PIP), in no net increase in the number of houses in the immediate area.
- 9.8 It should be noted that as the application is in principle, details of the exact siting, design, external material finishes, drainage and access for a house would be for a further Matters Specified in Conditions application to address.
- 9.9 Although the proposal is considered on its own to be contrary to development plan policy, the extant permission (17/05112/PIP) and its revocation, is a strong and significant material consideration which would allow for a positive recommendation to be made on the proposal. In addition, there is potential for this application to result in betterment to the community through the upgrading of the Leackin Brae/drove road access that would not otherwise have been possible. On balance, the proposal is recommended for approval, subject to the prior revocation of the extant permission (17/05112/PIP).
- 9.10 All relevant matters have been taken into account when appraising this application. It is considered that the proposal does not accord with the Development Plan however it is acceptable in terms of applicable material considerations.

10. IMPLICATIONS

- 10.1 Resource: Not applicable
- 10.2 Legal: Not applicable
- 10.3 Community (Equality, Poverty and Rural): Not applicable
- 10.4 Climate Change/Carbon Clever: Not applicable
- 10.5 Risk: Not applicable
- 10.6 Gaelic: Not applicable

11. RECOMMENDATION

Action required before decision issued	Y
Notification to Scottish Ministers	N
Conclusion of Section 75 Obligation	N
Revocation of previous permission	Y

Subject to the above actions, it is recommended to **GRANT** the application subject to the following conditions and reasons:

1. No development shall commence until all of the matters specified below have been approved on application to the Planning Authority:
 - i. a detailed layout of the site of the proposed development (including site levels as existing and proposed);
 - ii. the design and external appearance of the proposed development;
 - iii. landscaping proposals for the site of the proposed development (including boundary treatments);
 - iv. details of access and parking arrangements; and
 - v. details of the proposed water supply and drainage arrangements.

Reason: Planning permission is granted in principle only and these specified matters must be approved prior to development commencing.

2. Any details pursuant to Condition 1 above shall show a development featuring the following elements:
 - i. walls finished predominantly in a white/off-white wet-dash render/smooth coursed cement render/natural stone;
 - ii. a roof covering of natural slate;
 - iii. single storey or 1¾ storeys in height;
 - iv. windows with a strong vertical emphasis;
 - v. a roof symmetrically pitched of not less than 40° and not greater than 45°; and
 - vi. predominantly rectangular in shape with traditional gable ends.

Reason: In order to respect the vernacular building traditions of the area and integrate the proposal into its landscape setting; in the interests of visual amenity.

3. All foul water and surface water drainage provision within the application site shall be implemented in accordance with the approved plans and shall be completed prior to the first occupation of the development.

Reason: In order to ensure that private foul drainage infrastructure is suitably catered for, in the interests of public health and environmental protection; to ensure that surface water drainage is provided timeously and complies with the principles of SUDS; and in order to protect the water environment.

4. No development, site excavation or groundwork shall commence until a Tree Planting Plan and Maintenance Programme has been submitted to, and approved in writing by, the Planning Authority for trees to be planted a location with a surface area equivalent to those for trees felled on the site. The species and maturity of these trees shall be agreed as part of the Tree Planting Plan. The approved Tree Planting Plan shall be implemented in full during the first planting season following commencement of development, or as otherwise approved in writing by the Planning Authority, with maintenance thereafter being carried out in accordance with the approved Maintenance Programme.

Reason: In order to ensure that a high standard of landscaping is achieved, appropriate to the location of the site.

5. No development, site excavation or groundwork shall commence until full details of protective tree barriers have been submitted to, and approved in writing by, the Planning Authority. Thereafter, the approved barriers shall be erected prior to any development, site excavation or groundwork commencing and shall remain in place throughout the construction period. Barriers must not be moved or removed during the construction period without the prior written approval of the Planning Authority.

Reason: In order to ensure the protection of retained trees, which are important amenity assets, both during construction and thereafter.

6. No development shall commence until the footprint of the house, garage and driveway (along with any underground services due to be excavated) have been pegged out on the ground and all trees proposed for removal are clearly marked. Development shall only commence once these pegged out positions and marked trees have been approved in writing by the Planning Authority. No trees other than those approved for removal shall be cut down, uprooted, topped, lopped (including roots) or wilfully damaged in any way, and approved excavation and footprint locations shall not be altered, without the prior written approval of the Planning Authority.

Reason: In order to identify tree constraints and establish the developable area of the site.

7. No other development shall commence until the site access shown on the north boundary of the site has been constructed in accordance with The Highland Council's Access to Single Houses and Small Housing Developments guidelines, with:
- i. the junction formed to comply with drawing ref. SDB1; and
 - ii. visibility splays of 2.4m x 90m (the X dimension and Y dimension respectively) in each direction formed from the centre line of the junction.

Within the stated visibility splays, at no time shall anything obscure visibility between a driver's eye height of 1.05m positioned at the X dimension and an object height of 0.60m anywhere along the Y dimension.

Reason: In the interests of road traffic safety.

8. Prior to the commencement of any development, a scheme of works for the upgrading of Leachkin Brae and the drove road, including carriageway and passing place improvement, and surfacing works, shall be submitted to, and approved in writing by, the Planning Authority in consultation with the Roads Authority. The works required shall be implemented in accordance with the approved scheme, prior to the commencement of development on the application site

Reason: To provide a safe and suitable access to the site which does not involve the use of the Ladystone Farm Road and the substandard Overbridge 302/017.

9. Construction traffic and emergency vehicles shall not use the Bunchrew bridge (Overbridge 302/017) due to the weight restrictions on it and in view of the potential impact on the safety of the railway.

Reason: To provide a safe and suitable access to the site which does not involve the use of the Ladystone Farm Road and the substandard Overbridge 302/017.

10. No development shall commence on site until a Construction Traffic Management Plan (including a routing plan for construction vehicles) has been submitted to, and approved in writing by, the Planning Authority. The approved traffic management plan shall be implemented prior to development.

Reason: To ensure that an adequate level of access is timeously provided for the development; in the interests of road safety and amenity.

11. No part of the development shall interfere with the Core Path (LO19.50) during or after construction works, including:
- the placing of materials on the Core Path
 - allowing water, soil or any other substance to flow or spill onto the Core Path

- Erecting any fence or locked gates
- Prohibitory signs or notices
- Plant or overhang any vegetation on the Core Path
- Projections from building
- Parking vehicles

Reason To comply with the Council's statutory duty to uphold access rights.

12. Any disturbance or damage to the Core Path (LO19.50) shall be repaired to as good or better a standard than pre-development within 14 days of the disturbance occurring, or such longer period as agreed with the Planning Authority.

Reason: To comply with the Council's statutory duty to uphold access rights

13. No works shall commence until the Developer shall have prepared and have had agreed in writing by the Planning Authority in consultation with NatureScot, a red squirrel Species Protection Plan, including measures to mitigate the development. The Plan shall cover the application site and include mitigation measures where any impact, or potential impact, on red squirrels or their habitat has been identified. Development and work shall progress in accordance with any mitigation measures contained within the Plan and the timescales contain therein.

Reason: To minimise disturbance to nature conservation interests within the application site and ensure the protection of protected species and habitats

REASON FOR DECISION

All relevant matters have been taken into account when appraising this application. It is considered that the proposal accords with the principles and policies contained within the Development Plan and is acceptable in terms of all other applicable material considerations.

TIME LIMIT FOR THE IMPLEMENTATION OF THIS PLANNING PERMISSION

In accordance with Section 59 of the Town and Country Planning (Scotland) Act 1997 (as amended), an application or applications for the approval of matters specified in conditions attached to this planning permission in principle must be made no later than whichever is the latest of the following:

- i. The expiration of THREE YEARS from the date on this decision notice;
- ii. The expiration of SIX MONTHS from the date on which an earlier application for the requisite approval was refused; or
- iii. The expiration of SIX MONTHS from the date on which an appeal against such refusal was dismissed.

The development to which this planning permission in principle relates must commence no later than TWO YEARS from the date of the requisite approval of any matters specified in conditions (or, in the case of approval of different matters on

different dates, from the date of the requisite approval for the last such matter being obtained), whichever is the later. If development has not commenced within this period, then this planning permission in principle shall lapse.

INFORMATIVES

Initiation and Completion Notices

The Town and Country Planning (Scotland) Act 1997 (as amended) requires all developers to submit notices to the Planning Authority prior to, and upon completion of, development. These are in addition to any other similar requirements (such as Building Warrant completion notices) and failure to comply represents a breach of planning control and may result in formal enforcement action.

1. The developer must submit a Notice of Initiation of Development in accordance with Section 27A of the Act to the Planning Authority prior to work commencing on site.
2. On completion of the development, the developer must submit a Notice of Completion in accordance with Section 27B of the Act to the Planning Authority.

Copies of the notices referred to are attached to this decision notice for your convenience.

Accordance with Approved Plans & Conditions

You are advised that development must progress in accordance with the plans approved under, and any conditions attached to, this permission. You must not deviate from this permission without consent from the Planning Authority (irrespective of any changes that may separately be requested at the Building Warrant stage or by any other Statutory Authority). Any pre-conditions (those requiring certain works, submissions etc. prior to commencement of development) must be fulfilled prior to work starting on site. Failure to adhere to this permission and meet the requirements of all conditions may invalidate your permission or result in formal enforcement action

Scottish Water

You are advised that a supply and connection to Scottish Water infrastructure is dependent on sufficient spare capacity at the time of the application for connection to Scottish Water. The granting of planning permission does not guarantee a connection. Any enquiries with regards to sewerage connection and/or water supply should be directed to Scottish Water on 0845 601 8855.

Septic Tanks & Soakaways

Where a private foul drainage solution is proposed, you will require separate consent from the Scottish Environment Protection Agency (SEPA). Planning permission does not guarantee that approval will be given by SEPA and as such you are advised to contact them direct to discuss the matter (01349 862021).

Mud & Debris on Road

Please note that it is an offence under Section 95 of the Roads (Scotland) Act 1984 to allow mud or any other material to be deposited, and thereafter remain, on a public road from any vehicle or development site. You must, therefore, put in place a strategy for dealing with any material deposited on the public road network and maintain this until development is complete.

Construction Hours and Noise-Generating Activities

You are advised that construction work associated with the approved development (incl. the loading/unloading of delivery vehicles, plant or other machinery), for which noise is audible at the boundary of the application site, should not normally take place outwith the hours of 08:00 and 19:00 Monday to Friday, 08:00 and 13:00 on Saturdays or at any time on a Sunday or Bank Holiday in Scotland, as prescribed in Schedule 1 of the Banking and Financial Dealings Act 1971 (as amended).

Work falling outwith these hours which gives rise to amenity concerns, or noise at any time which exceeds acceptable levels, may result in the service of a notice under Section 60 of the Control of Pollution Act 1974 (as amended). Breaching a Section 60 notice constitutes an offence and is likely to result in court action.

If you wish formal consent to work at specific times or on specific days, you may apply to the Council's Environmental Health Officer under Section 61 of the 1974 Act. Any such application should be submitted after you have obtained your Building Warrant, if required, and will be considered on its merits. Any decision taken will reflect the nature of the development, the site's location and the proximity of noise sensitive premises. Please contact env.health@highland.gov.uk for more information.

Protected Species – Halting of Work

You are advised that work on site must stop immediately, and NatureScot must be contacted, if evidence of any protected species or nesting/breeding sites, not previously detected during the course of the application and provided for in this permission, are found on site. For the avoidance of doubt, it is an offence to deliberately or recklessly kill, injure or disturb protected species or to damage or destroy the breeding site of a protected species. These sites are protected even if the animal is not there at the time of discovery. Further information regarding protected species and developer responsibilities is available from NatureScot: <https://www.nature.scot/professional-advice/protected-areas-and-species/protected-species>

Signature: David Mudie
Designation: Area Planning Manager – South
Author: Keith Gibson
Background Papers: Documents referred to in report and in case file.
Relevant Plans: Plan 1 - 18-01-LP-MRH REV Location Plan

Plan 2 - 18-01-LP-MRH REV A Block Plan

Plan 3 - 18-01-LP-MRH REV A General Plan - Site Layout and Elevations

Plan 4 - Tree Protection Plan

Plan 5 - Tree Planting Plan

LADYSTONE HOUSE PLOT-LEACHKIN-INVERNESS

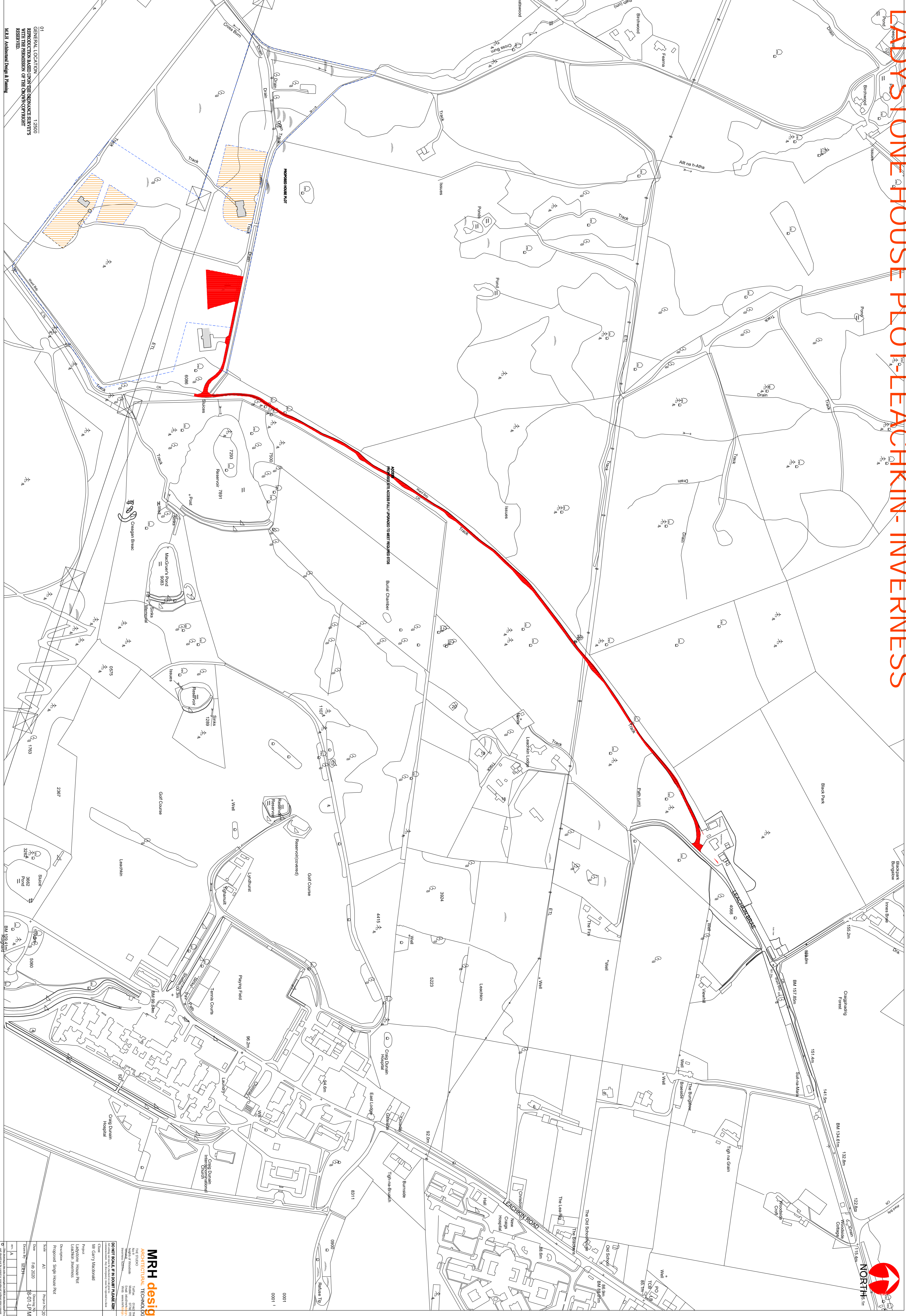

01
GENERAL LOCATION
WITH THE PERMISSION OF THE SHOWN CONTRACT
RESERVED.
M.R.H. Architectural Design & Planning

MRH design
ARCHITECTURAL TECHNOLOGY

Client: Mr Gary Macdonald
Project: Ladystone House Plot
Location: Inverness
Description: Proposed Single House Plot

Scale: A1
Date: Feb 2020
Drawing No: 2018-01

1:000
1:500
1:1000
1:2000
1:5000
1:10000

DO NOT SCALE & IN ORDER PLEASE ASK

0001
0001
0001

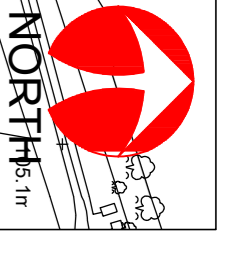

LADYSTONE-HOUSE PLOT LEACHKIN-INVERNESS

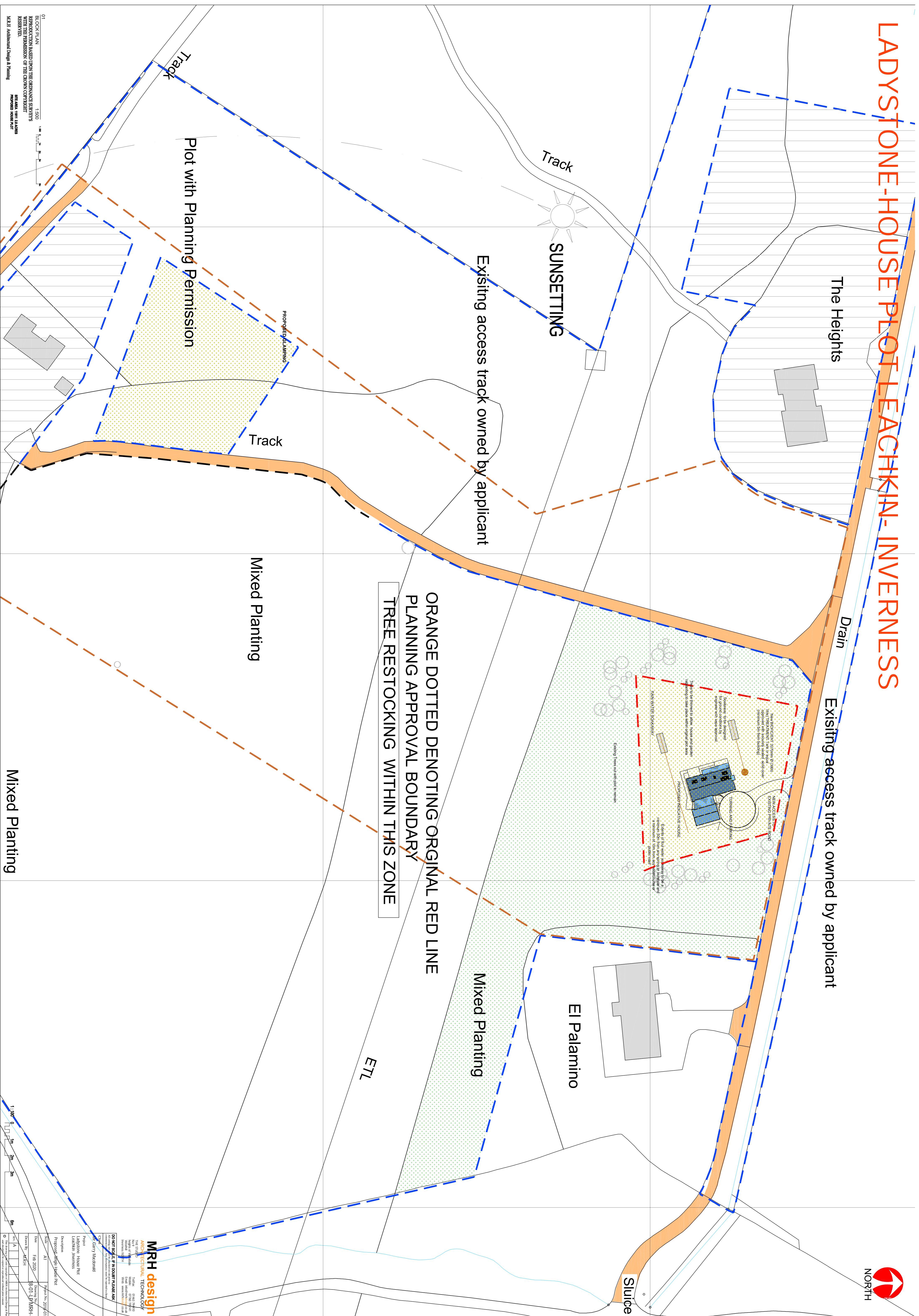

ORANGE DOTTED DENOTING ORIGINAL RED LINE PLANNING APPROVAL BOUNDARY TREE RESTOCKING WITHIN THIS ZONE

Existing access track owned by applicant

Existing access track owned by applicant

Track

SUNSETTING

The Heights

Drain

Plot with Planning Permission

Track

Mixed Planting

El Palamino

Mixed Planting

ETL

Sluice

Mixed Planting

BLOCK PLAN
1:500
1" = 4'
1:1000
1" = 100'
1:2000
1" = 200'
1:5000
1" = 500'
1:10000
1" = 1000'

1:1000 0 1m 2m 3m 5m

MRH design
ARCHITECTURAL TECHNOLOGY
148, 150, 152, 154, 156, 158, 160, 162, 164, 166, 168, 170, 172, 174, 176, 178, 180, 182, 184, 186, 188, 190, 192, 194, 196, 198, 200, 202, 204, 206, 208, 210, 212, 214, 216, 218, 220, 222, 224, 226, 228, 230, 232, 234, 236, 238, 240, 242, 244, 246, 248, 250, 252, 254, 256, 258, 260, 262, 264, 266, 268, 270, 272, 274, 276, 278, 280, 282, 284, 286, 288, 290, 292, 294, 296, 298, 300, 302, 304, 306, 308, 310, 312, 314, 316, 318, 320, 322, 324, 326, 328, 330, 332, 334, 336, 338, 340, 342, 344, 346, 348, 350, 352, 354, 356, 358, 360, 362, 364, 366, 368, 370, 372, 374, 376, 378, 380, 382, 384, 386, 388, 390, 392, 394, 396, 398, 400, 402, 404, 406, 408, 410, 412, 414, 416, 418, 420, 422, 424, 426, 428, 430, 432, 434, 436, 438, 440, 442, 444, 446, 448, 450, 452, 454, 456, 458, 460, 462, 464, 466, 468, 470, 472, 474, 476, 478, 480, 482, 484, 486, 488, 490, 492, 494, 496, 498, 500, 502, 504, 506, 508, 510, 512, 514, 516, 518, 520, 522, 524, 526, 528, 530, 532, 534, 536, 538, 540, 542, 544, 546, 548, 550, 552, 554, 556, 558, 560, 562, 564, 566, 568, 570, 572, 574, 576, 578, 580, 582, 584, 586, 588, 590, 592, 594, 596, 598, 600, 602, 604, 606, 608, 610, 612, 614, 616, 618, 620, 622, 624, 626, 628, 630, 632, 634, 636, 638, 640, 642, 644, 646, 648, 650, 652, 654, 656, 658, 660, 662, 664, 666, 668, 670, 672, 674, 676, 678, 680, 682, 684, 686, 688, 690, 692, 694, 696, 698, 700, 702, 704, 706, 708, 710, 712, 714, 716, 718, 720, 722, 724, 726, 728, 730, 732, 734, 736, 738, 740, 742, 744, 746, 748, 750, 752, 754, 756, 758, 760, 762, 764, 766, 768, 770, 772, 774, 776, 778, 780, 782, 784, 786, 788, 790, 792, 794, 796, 798, 800, 802, 804, 806, 808, 810, 812, 814, 816, 818, 820, 822, 824, 826, 828, 830, 832, 834, 836, 838, 840, 842, 844, 846, 848, 850, 852, 854, 856, 858, 860, 862, 864, 866, 868, 870, 872, 874, 876, 878, 880, 882, 884, 886, 888, 890, 892, 894, 896, 898, 900, 902, 904, 906, 908, 910, 912, 914, 916, 918, 920, 922, 924, 926, 928, 930, 932, 934, 936, 938, 940, 942, 944, 946, 948, 950, 952, 954, 956, 958, 960, 962, 964, 966, 968, 970, 972, 974, 976, 978, 980, 982, 984, 986, 988, 990, 992, 994, 996, 998, 1000

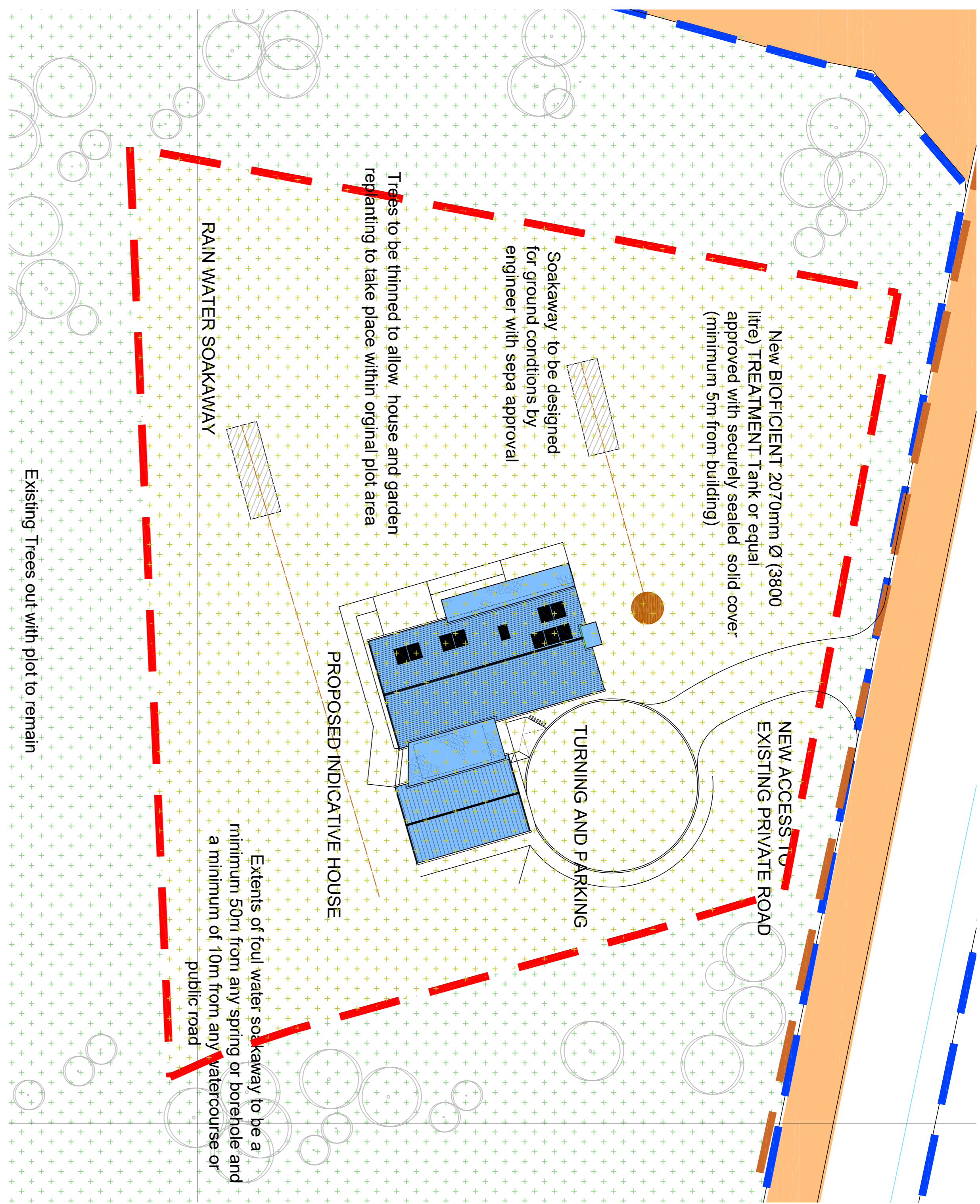

01 BLOCK PLAN 1:200

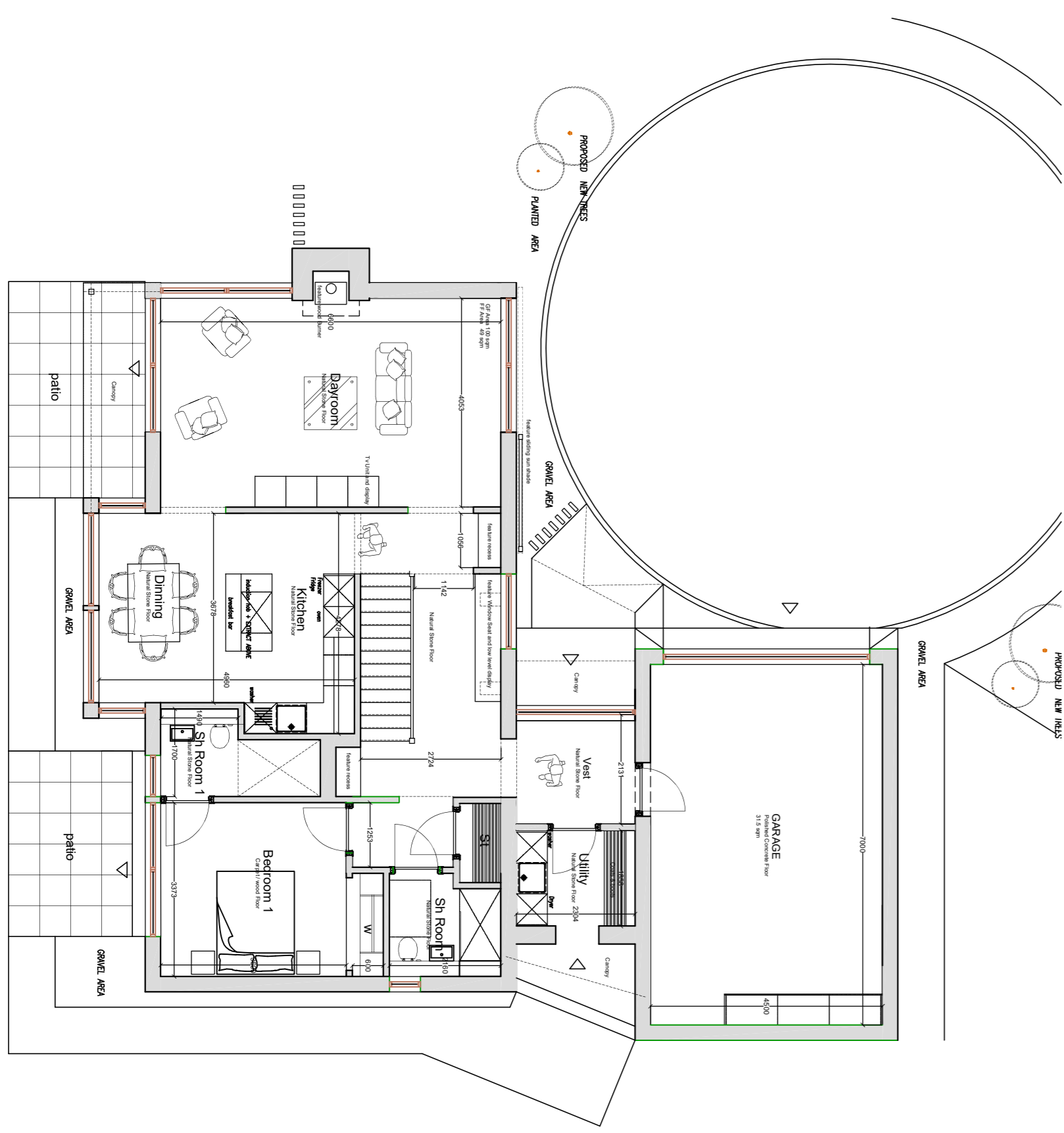

02 PROPOSED GROUND FLOOR PLAN 1:100



03 PROPOSED FIRST FLOOR PLAN 1:100

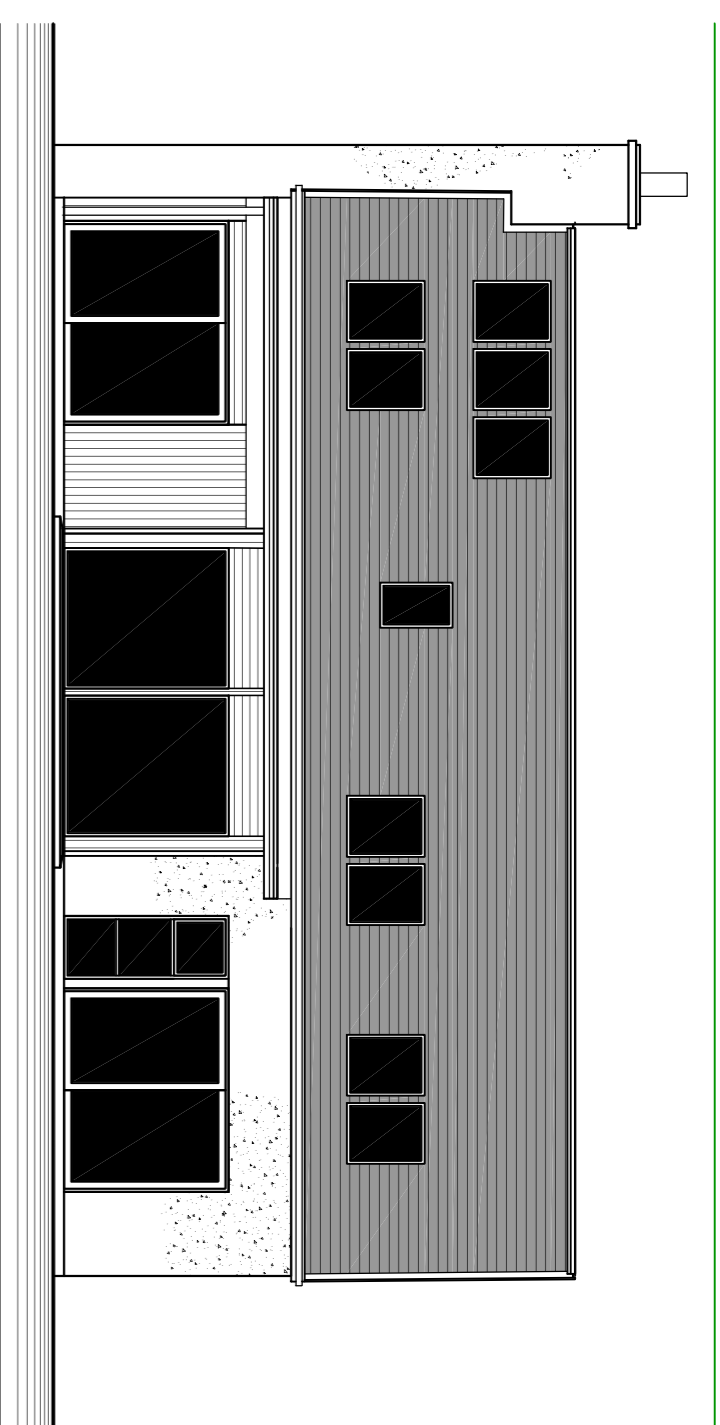

04 SOUTH WEST ELEVATION 1:100

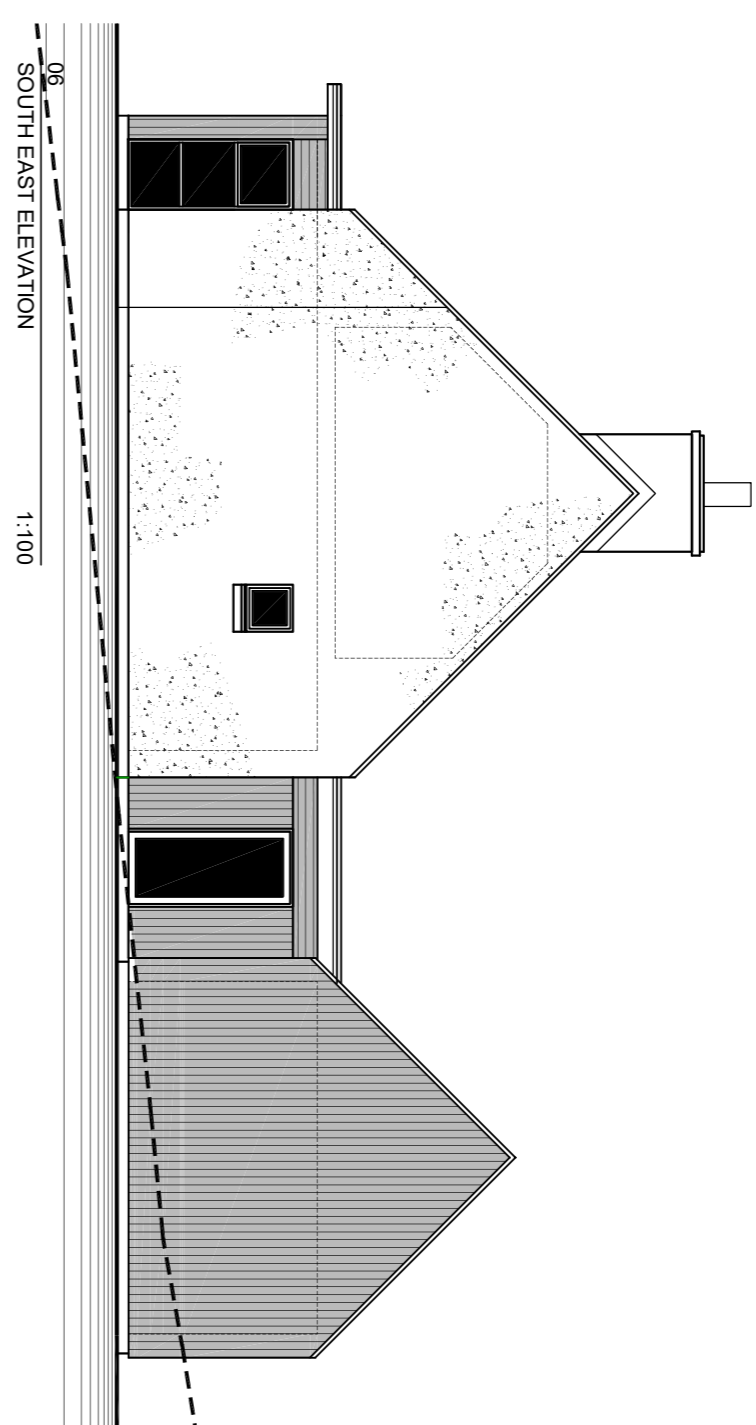

06 SOUTH EAST ELEVATION 1:100

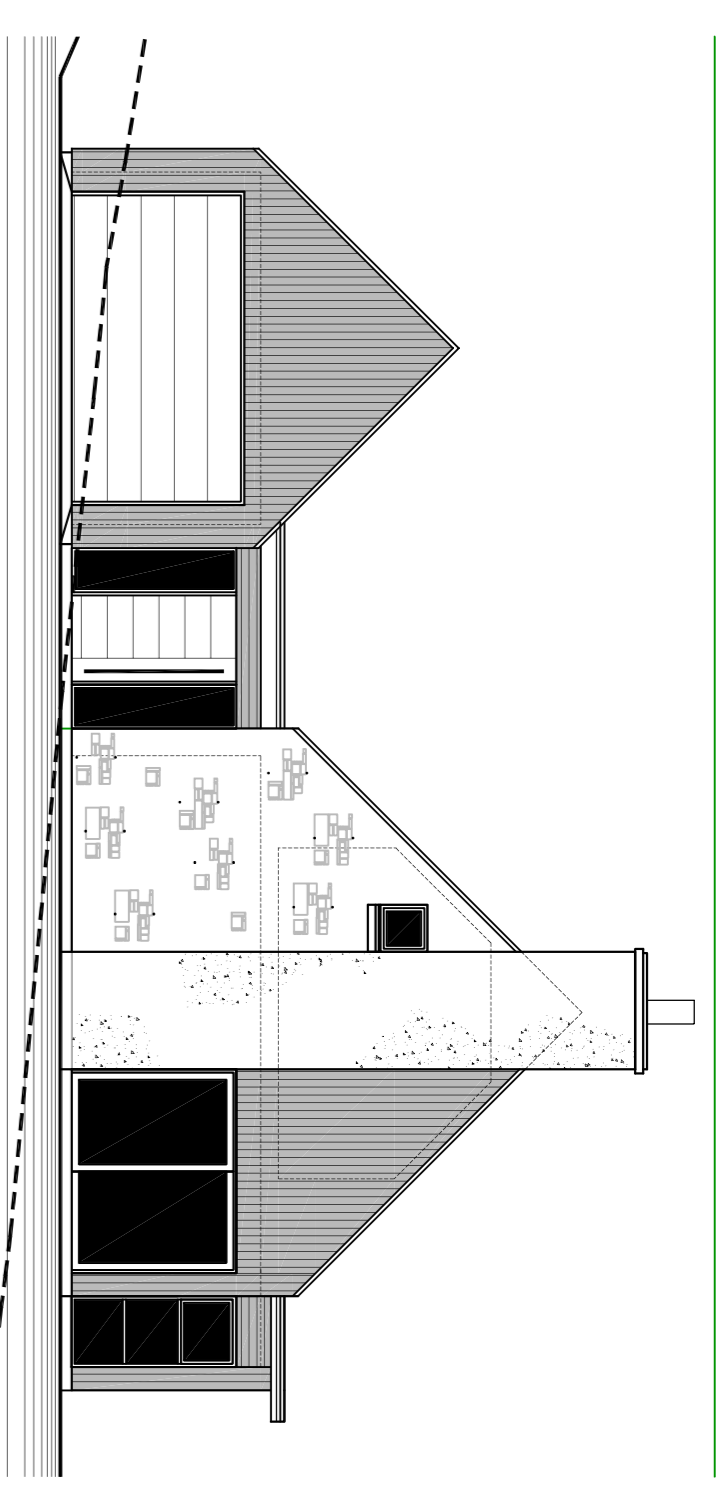

05 NORTH WEST ELEVATION 1:100

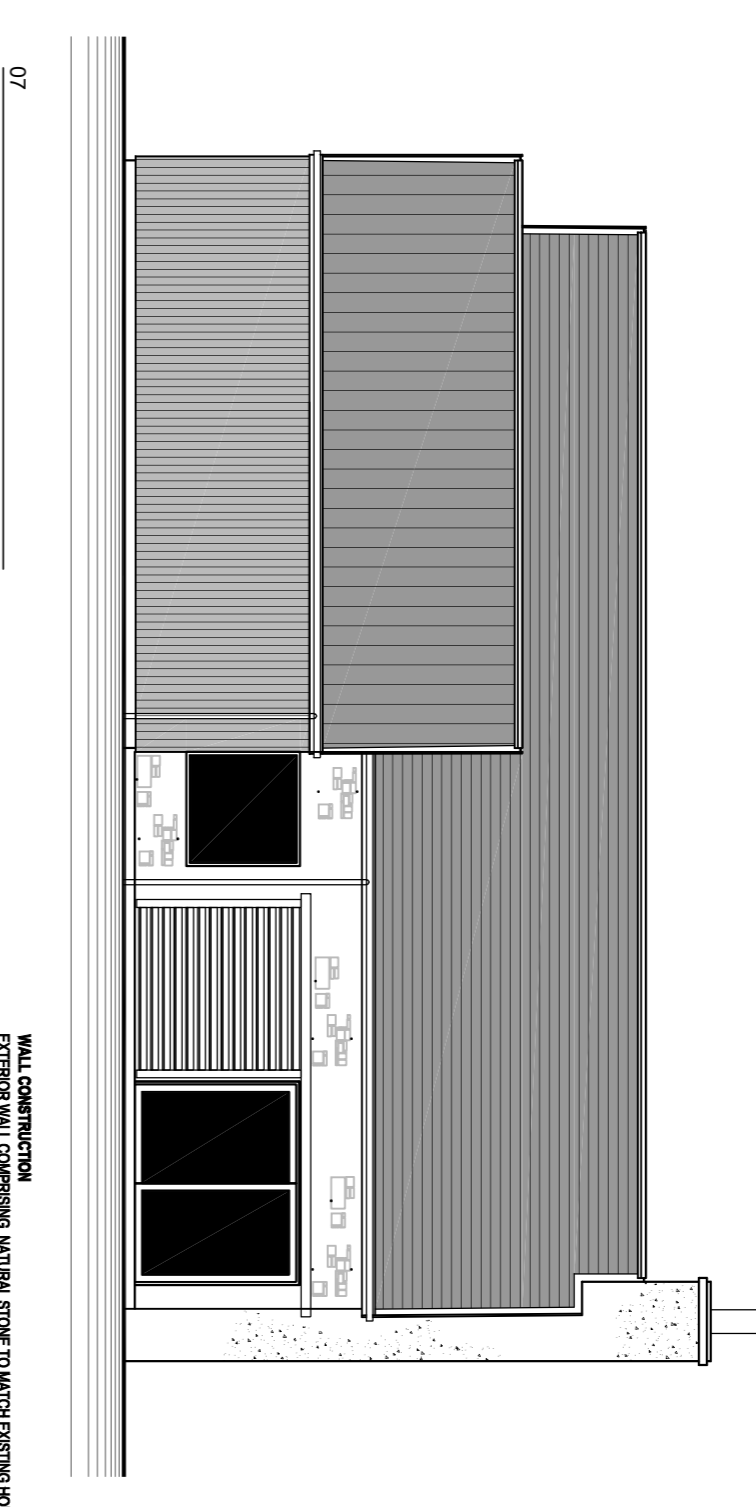

07 NORTH EAST ELEVATION 1:100

NOTE: COMPARE MATERIALS TO MATCH EXISTING HOUSE SOME ELEMENTS OF TYPICAL CLADDING SET
 ALL WINDOWS AND DOORS TO BE HIGH PERFORMANCE DOUBLE GLAZED WITH WHITENED GLASS TO MATCH IN STYLE AND PROPORTIONS.
ROOF: TO BE NATURAL SLATE
FACED & EXTERIOR WALLS: TO MATCH EXISTING

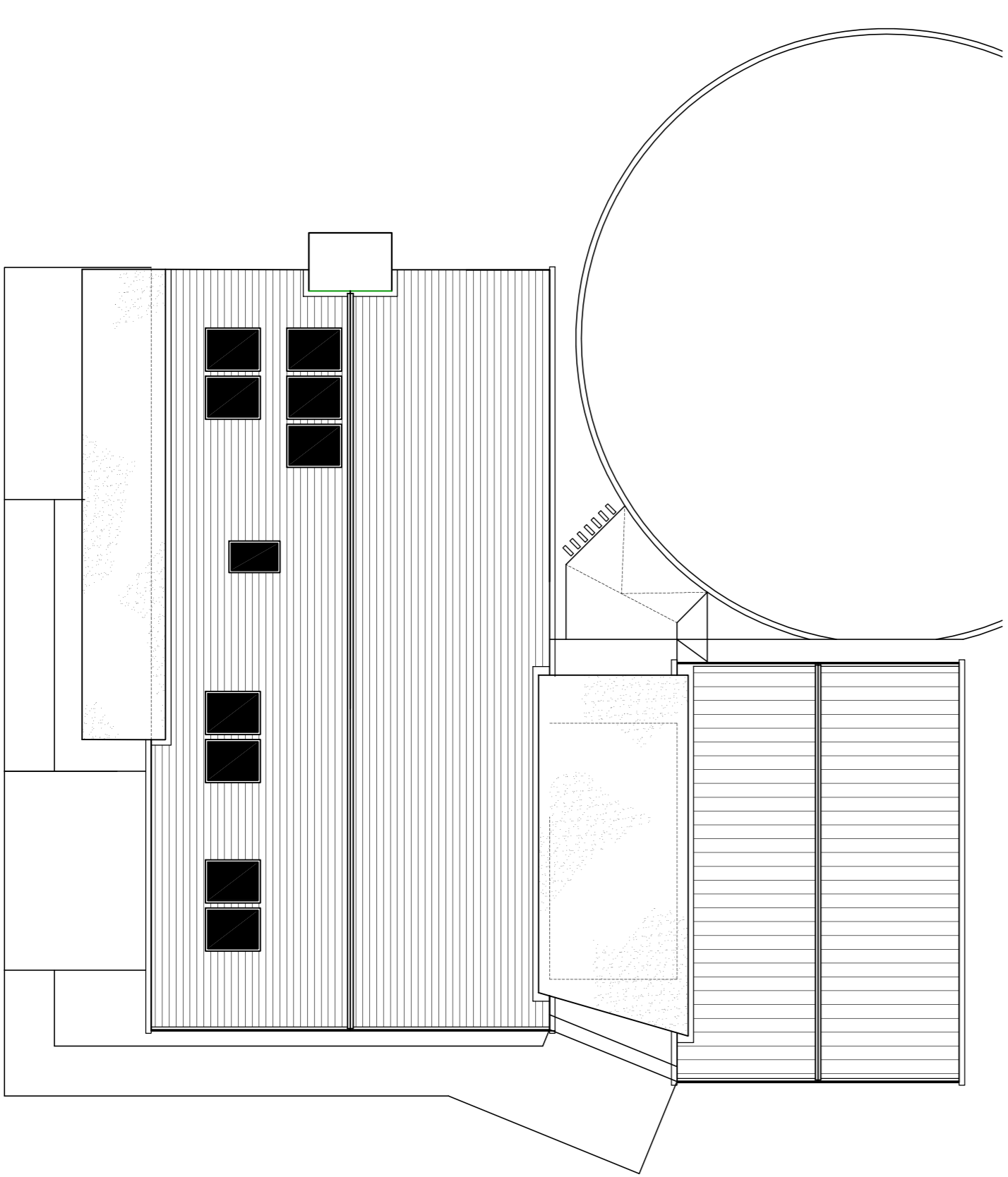

08 PROPOSED ROOF PLAN 1:100

TREE PROTECTION PLAN

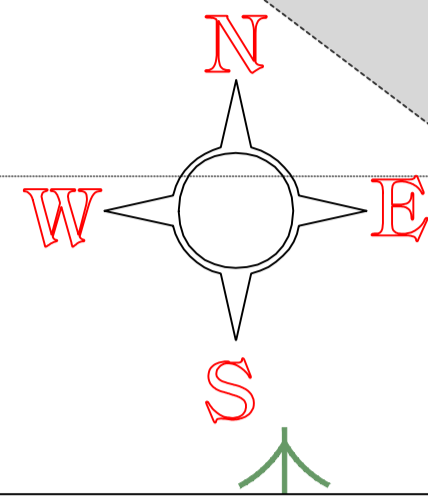

Urban-Arb
Arboricultural Consultants

Tree Protection Guidelines

In order to safeguard the trees on this site please observe the following:

- Do not move the tree protection barriers
- Do not enter the protected area
- Report any damage to protection barriers at the site office
- Do not use the area within the protection barriers to store or mix materials
- Do not carry out any excavation works within the protection barriers
- Avoid handling fuels or liquid contaminants within 10 metres of the protected area.

In the event of damage to a retained tree on this site please contact:

Arboriculturist: Callum McCutcheon
Tel: (01343) 821763
Mob: 07766735488

W: www.urban-arb.com Email: callum@urban-arb.com Tel: 01343 821763/07766 735488
Urban-Arb LLP is a Limited Liability Partnership. Registered in Scotland. Registered Office: 11 The Muir, Bogmoor, Spey Bay, Fochabers, Moray IV32 7PN. Partnership No. SC032982

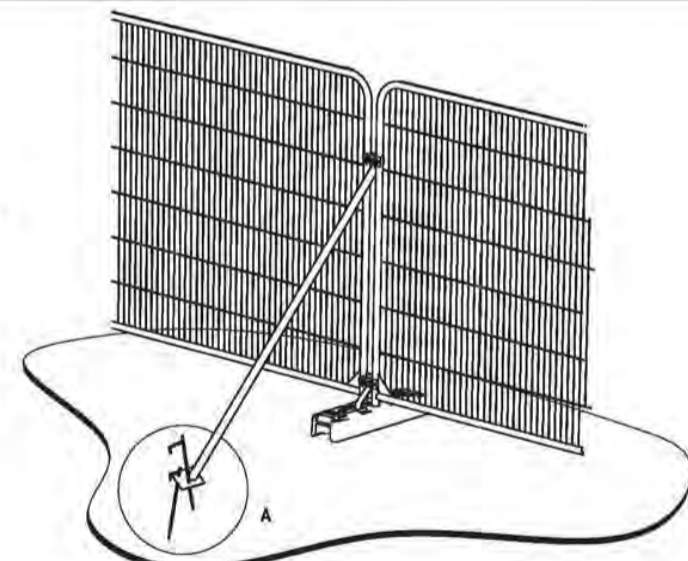
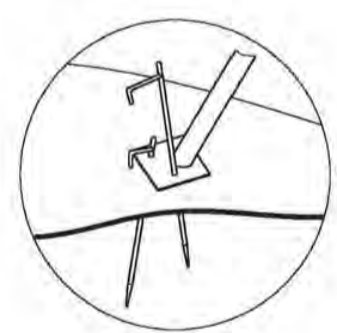

a) Stabilizer strut with base plate secured with ground pins

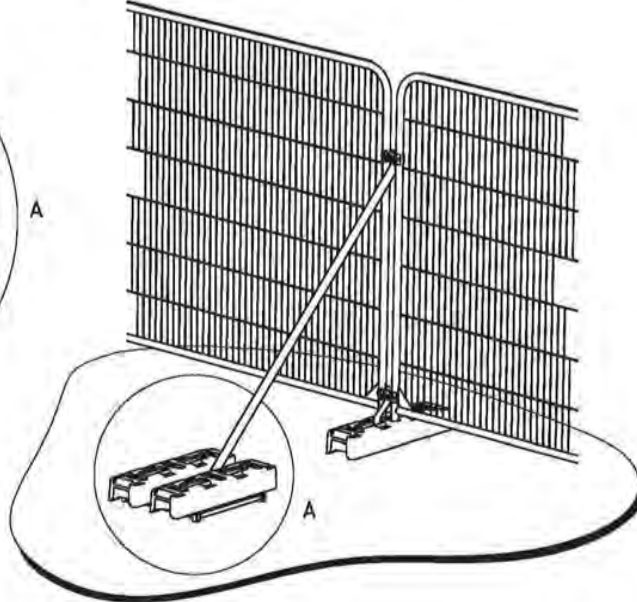
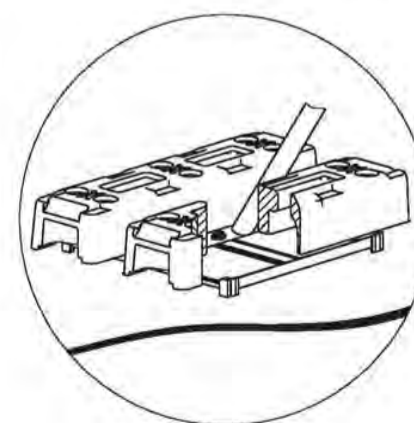

b) Stabilizer strut mounted on block tray

Tree Protection Barrier Specification

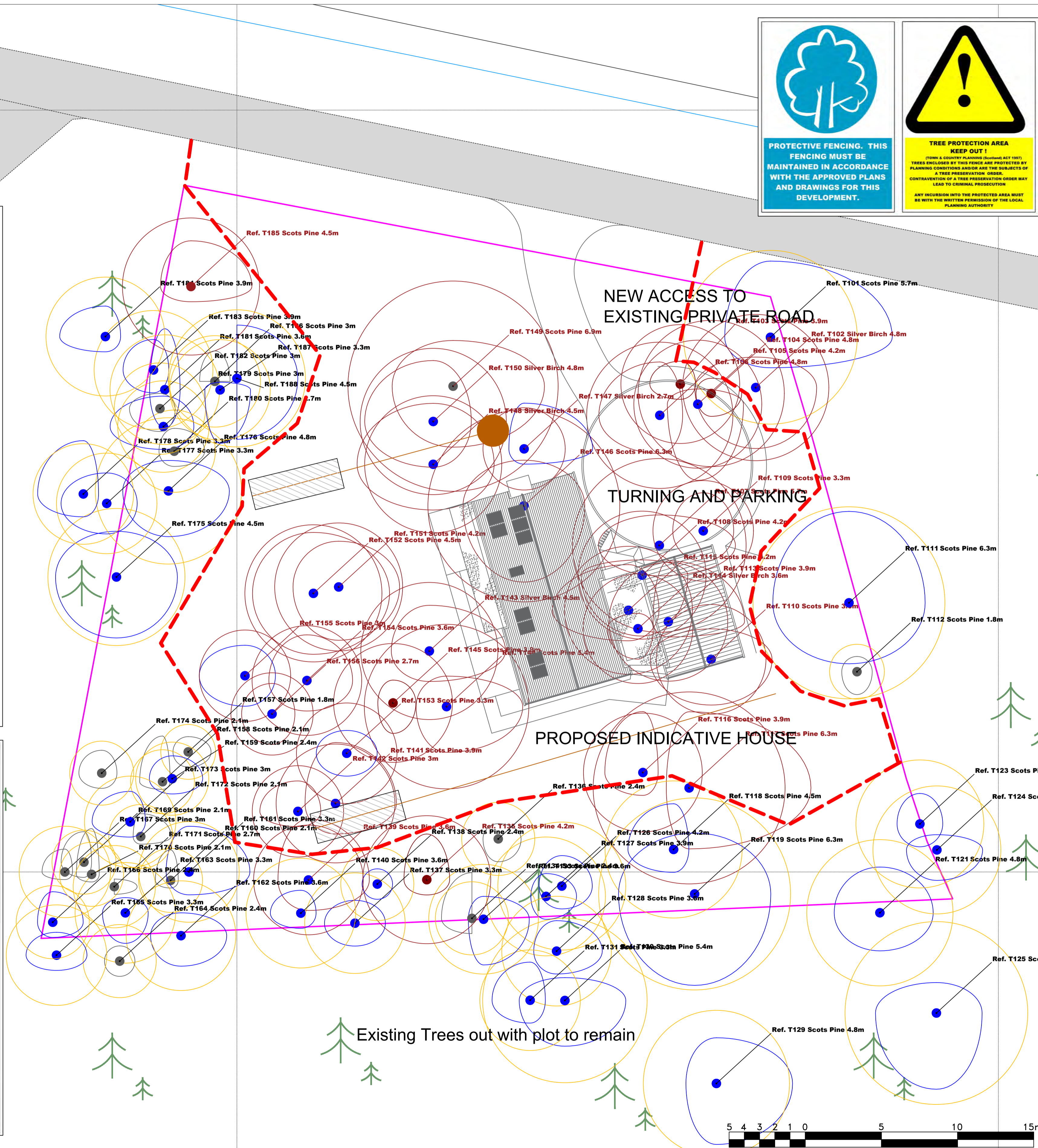

PROTECTIVE FENCING. THIS MUST BE MAINTAINED IN ACCORDANCE WITH THE APPROVED PLANS AND DRAWINGS FOR THIS DEVELOPMENT.

TREE PROTECTION AREA KEEP OUT!
TREES ENCLOSED BY THIS FENCE ARE PROTECTED BY PLANNING CONDITIONS AND ARE THE SUBJECTS OF A TREE PRESERVATION ORDER. CONTRAVENTION OF A TREE PRESERVATION ORDER MAY LEAD TO CRIMINAL PROSECUTION.
ANY INCURSION INTO THE PROTECTED AREA MUST BE WITH THE WRITTEN PERMISSION OF THE LOCAL PLANNING AUTHORITY.

General Notes

KEY

- Tree Reference, Common Name and Root Protection Area radius
- Stem
- Tree Canopy
- Root Protection Area (RPA)

Colours are in accordance with BS5837:2012 quality grading:

Red: Unsuitable for retention
Grey: Low quality
Blue: Moderate quality
Green: High quality

Root Protection Area (RPA): The minimum area around a tree deemed to contain sufficient roots and rooting volume to maintain the tree's viability, and where the protection of the roots and soil structure is treated as a priority (BS5937:2012)

TREE TO BE REMOVED

- Ref: T001 Silver Birch 2.7m

--- Tree Protection Fencing
--- Site Boundary

Tree survey performed by Callum McCutcheon BSc (Hons) M.Arbor.A on 06.08.2020

Urban-Arb
Arboricultural Consultants

No.	Revision/Issue	Date

Firm Name and Address
Urban-Arb LLP
Dolphin Cottage
11 The Muir
Bogmoor
Spey Bay
Fochabers
Moray IV32 7PN
www.urban-arb.com

Project Name and Address
Proposed House Plot
Ladystone
Inverness
20/01442/PIP

Project TREE PROTECTION PLAN	Sheet
Date 09.08.2020	1 of 1
Scale 1:150@A1	

TREE PLANTING PLAN. Rev A

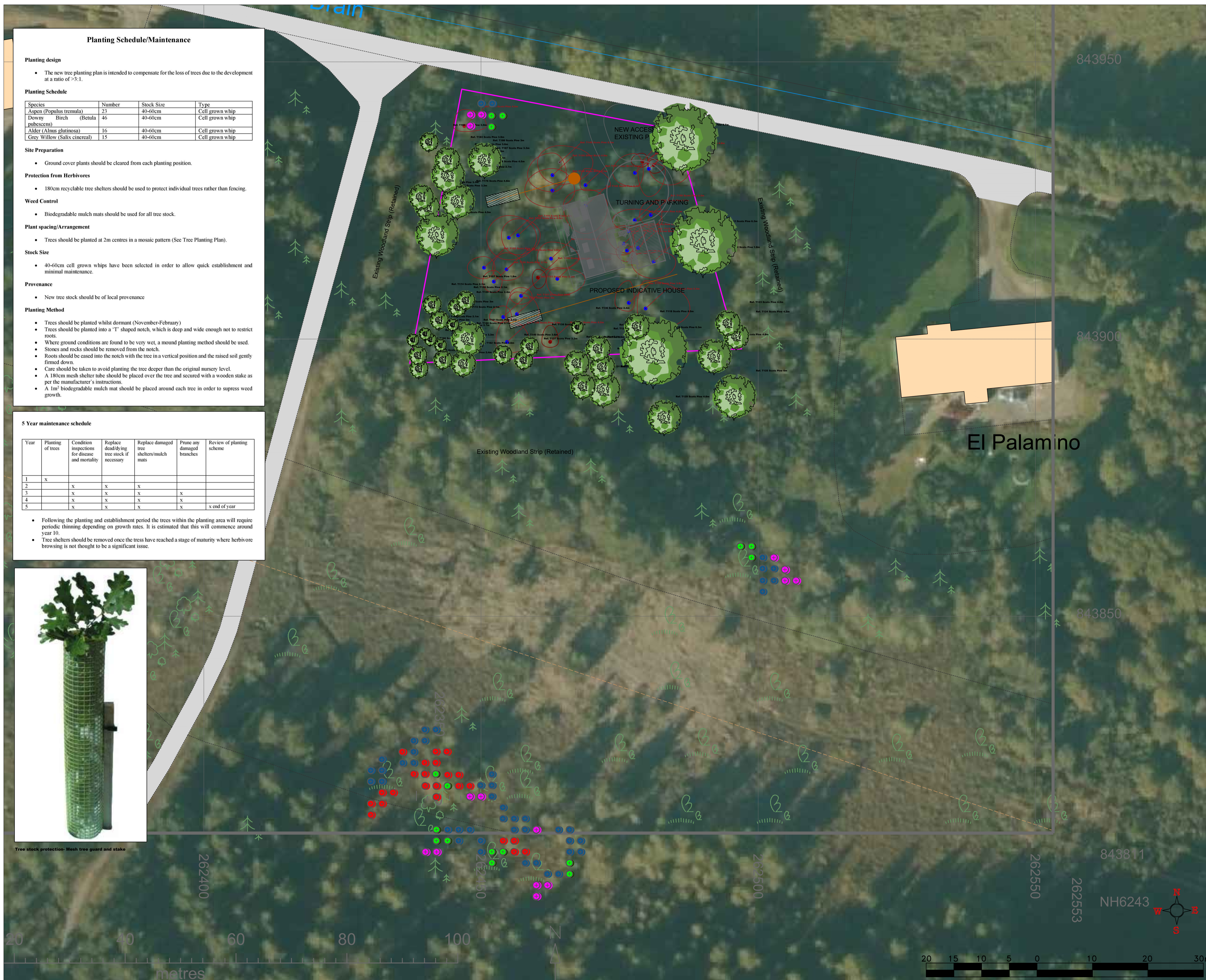

Planting Schedule/Maintenance

Planting design

- The new tree planting plan is intended to compensate for the loss of trees due to the development at a ratio of >3:1.

Planting Schedule

Species	Number	Stock Size	Type
Aspen (<i>Populus tremula</i>)	23	40-60cm	Cell grown whip
Downy Birch (<i>Betula pubescens</i>)	46	40-60cm	Cell grown whip
Alder (<i>Alnus glutinosa</i>)	16	40-60cm	Cell grown whip
Grey Willow (<i>Salix cinerea</i>)	15	40-60cm	Cell grown whip

Site Preparation

- Ground cover plants should be cleared from each planting position.

Protection from Herbivores

- 180cm recyclable tree shelters should be used to protect individual trees rather than fencing.

Weed Control

- Biodegradable mulch mats should be used for all tree stock.

Plant spacing/Arrangement

- Trees should be planted at 2m centres in a mosaic pattern (See Tree Planting Plan).

Stock Size

- 40-60cm cell grown whips have been selected in order to allow quick establishment and minimal maintenance.

Provenance

- New tree stock should be of local provenance.

Planting Method

- Trees should be planted whilst dormant (November-February).
- Trees should be planted into a "T" shaped notch, which is deep and wide enough not to restrict roots.
- Where ground conditions are found to be very wet, a mound planting method should be used.
- Stones and rocks should be removed from the notch.
- Roots should be eased into the notch with the tree in a vertical position and the raised soil gently firmed down.
- Care should be taken to avoid planting the tree deeper than the original nursery level.
- A 180cm mesh shelter tube should be placed over the tree and secured with a wooden stake as per the manufacturer's instructions.
- A 1m² biodegradable mulch mat should be placed around each tree in order to suppress weed growth.

5 Year maintenance schedule

Year	Planting of trees	Condition inspections for disease and mortality	Replace dead/dying tree stock if necessary	Replace damaged tree shelters/mulch mats	Prune any damaged branches	Review of planting scheme
1	x					
2		x	x	x		
3		x	x	x	x	
4		x	x	x	x	
5		x	x	x	x	x end of year

- Following the planting and establishment period the trees within the planting area will require periodic thinning depending on growth rates. It is estimated that this will commence around year 10.
- Tree shelters should be removed once the trees have reached a stage of maturity where herbivore browsing is not thought to be a significant issue.



Tree stock protection- Mesh tree guard and stake

General Notes

- 40-60cm cell grown Aspen (*Populus tremula*). 23 No. 2x2m spacing
- 40-60cm cell grown Downy Birch (*Betula pubescens*). 46 No. 2x2m spacing
- 40-60cm cell grown Alder (*Alnus glutinosa*). 16 No. 2x2m spacing
- 40-60cm cell grown Grey Willow (*Salix cinerea*). 15 No. 2x2m spacing
- Existing retained tree within or close to site boundary
- Tree within site boundary to be removed to allow development

Total Number of new trees: 100

Trees to be planted whilst dormant (Nov-March). Spacing 2m x 2m as per plan. Exact positions to be micro-sited away from existing trees.

Herbivore protection 180cm mesh tree guards.

Weed control: biodegradable mulch mats to be used for all stock.

Planting mix includes broadleaved native trees suited to wet ground. Species mix chosen to maximise habitat value and positioned in order to avoid the route of the power line.

Tree survey performed by Callum McCutcheon BSc (Hons) M.Arbor.A on 06.08.2020



No.	Revision/Issue	Date

Firm Name and Address
Urban-Arb LLP
 Dolphin Cottage
 11 The Muir
 Bogmoor
 Spey By
 Fochabers
 Moray IV32 7PN
 www.urban-arb.com

Project Name and Address
Proposed House Plot
Ladystone
Inverness
20/01442/PIP

Project	Sheet
TREE PLANTING PLAN	
Date	
17.08.2020	1 of 1
Scale	
1:350@A1	